

## MULTI-PURPOSE LID (DOUBLE DOOR)

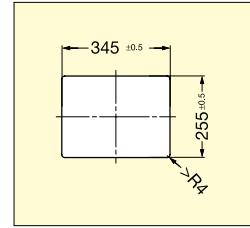

## AZ-DD310/HL

- Synchronized doors allow for easy opening.
- 304 Stainless Steel lid and frame.

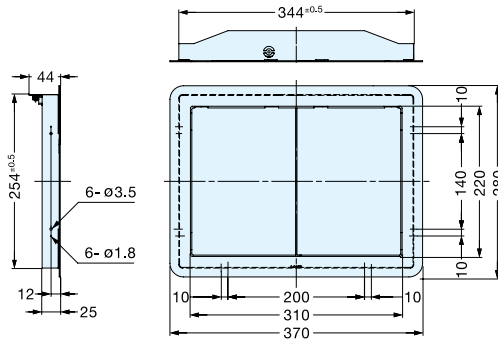

Cut Out Dimensions

Item No.	Weight (kg)	Box (pcs)	Carton (pcs)	Material	Finish
AZ-DD310/HL	2.2	1	10	304 Stainless Steel	Satin

## MULTI-PURPOSE LID (SQUARE BEZEL)



## AZ-ND

- Corrosion resistant.
- 304 Stainless Steel



AZ-ND230HL



AZ-ND310HL

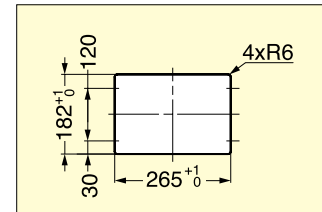
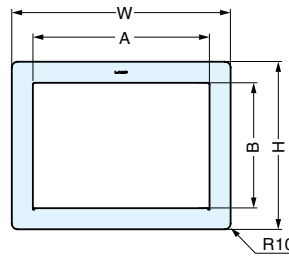
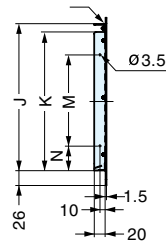
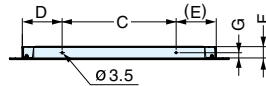

AZ-ND230HL Cut Out Dimensions

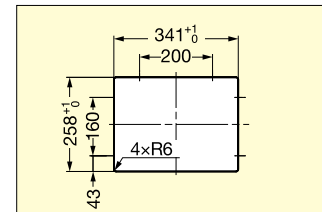

AZ-ND310HL Cut Out Dimensions

Item No.	Material	Finish	A	B	W	H
AZ-ND230HL	Stainless Steel (SUS304)	Satin	234 ( 9-7/32" )	160 (6-19/64")	308 (12-1/8")	234 ( 9-7/32" )
AZ-ND310HL			310 (12-13/64")	220 (8-21/32")	384 (15-1/8")	394 (15-33/64")

Item No.	C	D	E	F	G	J	K	M	N	Weight (kg)
AZ-ND230HL	-	-	-	-	-	-	170	120	30	0.72
AZ-ND310HL	200	70	70	20	10	257	243	160	43	1.05