

CABINET LOCK



3310



- Brass cylinder lock.
- Cylinder rotates for either drawer or cabinet door application.
- Cylinder Diameter: 18 mm (11/16")
- 156 key changes available; Please specify keyed alike or differently when ordering.
- Master key NOT available.
- Keys can be shared with other 3300 series locks.
- 4 mm (5/32") plastic distance plate TSSP available for various door thickness. See below.

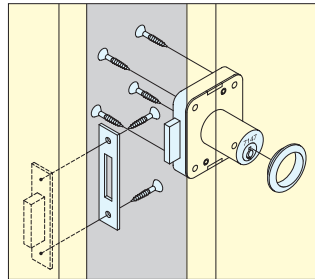
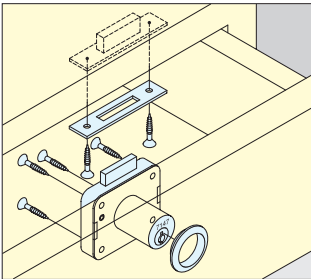
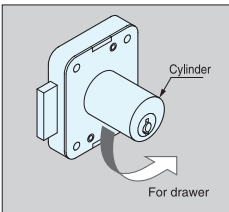
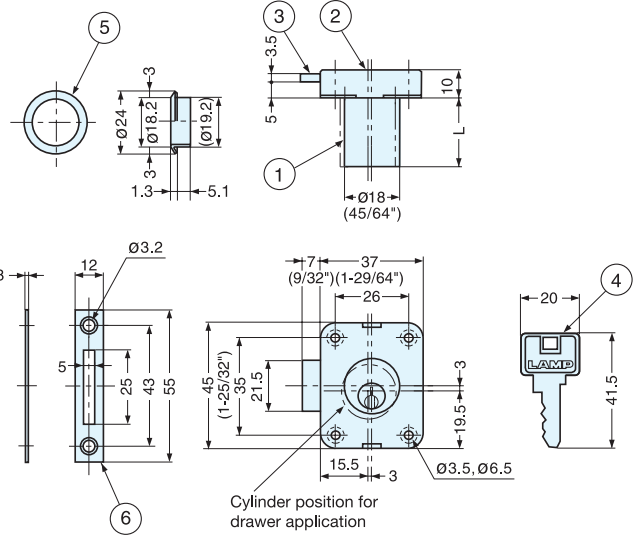

No.	Part Name	Material	Finish
①	Cylinder Housing	Brass	Nickel
②	Body		
③	Dead Bolt		
④	Key		
⑤	Ring	304 Stainless Steel	-
⑥	Counterplate		

Item No.	L	Door Thickness	Weight (g)	Box (pcs)	Carton (pcs)
3310-24	24 (15/16")	24 (15/16")	116	12	120
3310-30	30 (1-3/16")	30 (1-3/16")	125		

SPACER

TSSP

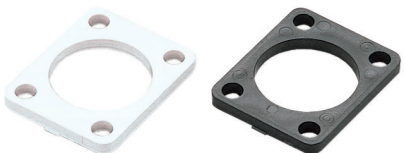

- Spacer for 2100, 2200, 2650, 3310, and 3320 locks.
- Use when additional distance on dimension B is required.
- Thickness: 4mm (5/32")
- Multiple spacers can be used if needed.

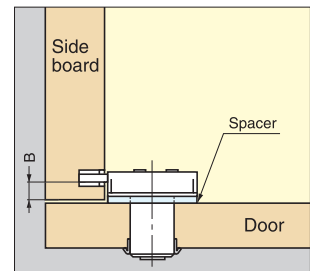
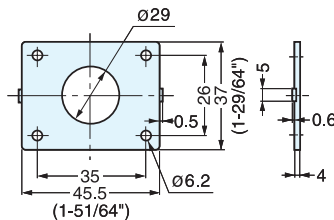

Item No.	Weight (g)	Box (pcs)	Carton (pcs)	Material	Color	
TSSP-W	TSSP-B	14	150	1500	ABS	White/Black