

MAGNETIC TOUCH LATCH

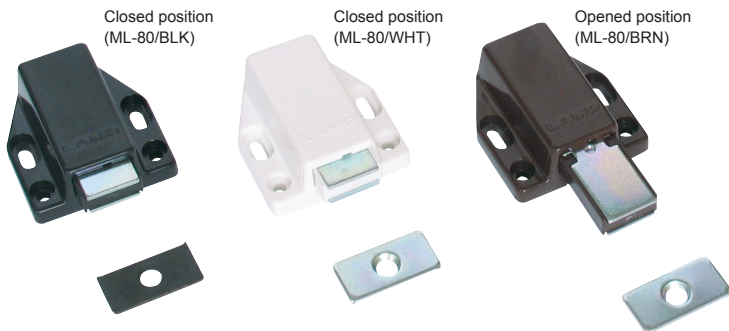

ML-80



- Push to latch/unlatch.
- Eliminates need for handles or knobs.
- Only white and brown RoHS compliant.
- Note: Allow a 3.5 mm (1/8") gap between door and cabinet frame for pushing room.

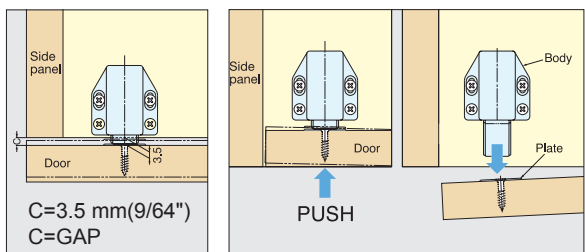

Installation

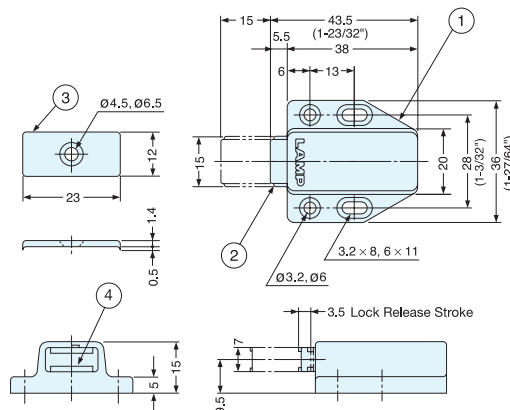

Item No.	RoHS	Magnetic Force (kg)	Weight (g)	Box (pcs)	Carton (pcs)
ML-80/WHT	Yes	1.6 (3.5 lbs)	22	20	400
ML-80/BRN					
ML-80/BLK	No				

No.	Part Name	Material	Finish/Color
①	Body	ABS	White (WHT), Brown (BRN), Black (BLK)
②	Latch	Steel	Yellow Zinc Chromate
③	Counterplate		
④	Magnet	Ferrite	-

MAGNETIC TOUCH LATCH (LONG STROKE)



ML-120



- Long stroke for medium size doors.
- Push to latch/unlatch.
- Eliminates need for handles or knobs.
- Note: Allow a 3.5 mm (1/8") gap between door and cabinet frame for pushing room.
- CPSIA Compliant for furniture.

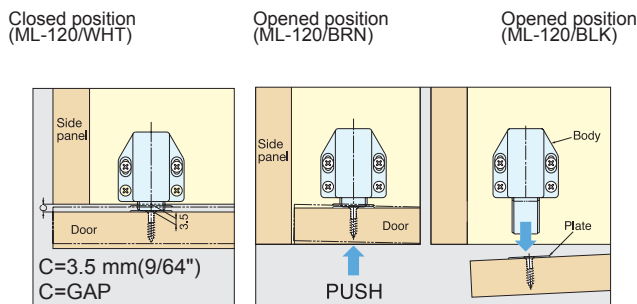

Installation

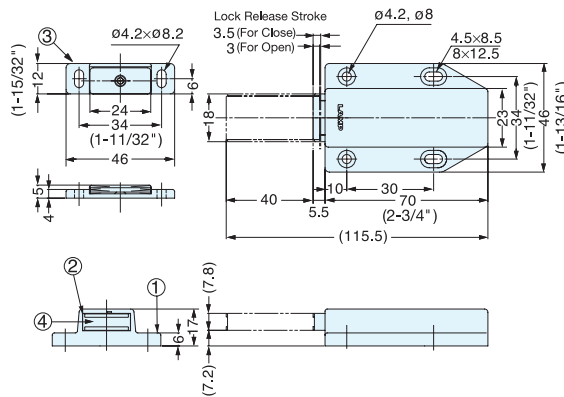

Item No.	Magnetic Force (kg)	Weight (g)	Box (pcs)	Carton (pcs)
ML-120/WHT	2.4 (5.3 lbs)	53	20	240
ML-120/BRN				
ML-120/BLK				

No.	Part Name	Material	Finish/Color
①	Body	ABS	White (WHT)/Brown (BRN)/Black (BLK)
②	Latch	Steel	Yellow Zinc Chromate
③	Counterplate		
④	Magnet	Ferrite	-