

DOOR HOLDER



YA-2020, 2020W

LID SUPPORTS

DOOR HOLDERS

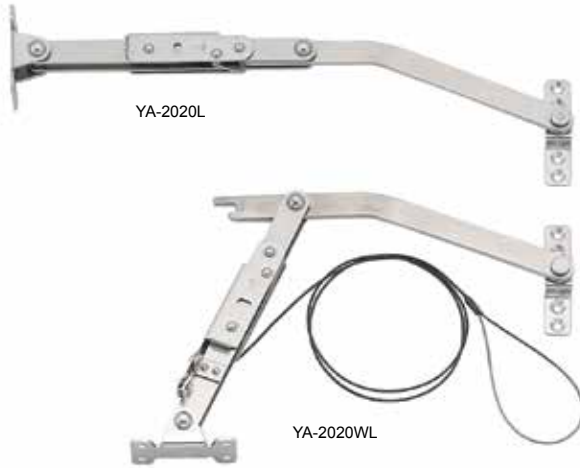

- Automatically locks door when fully opened.
- Slide the locking lever to release lock. Locking grip will stay unlocked until the door is moved for easy handling.
- YA-2020WR/WL (with lock release wire) available for tall applications.
- Left-handed and Right-handed models available.
- Tensile Force: Max. 330 lbs (150 kg)
- Compression Load: Max. 132 lbs (60 kg)

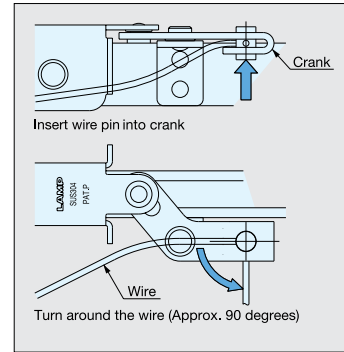
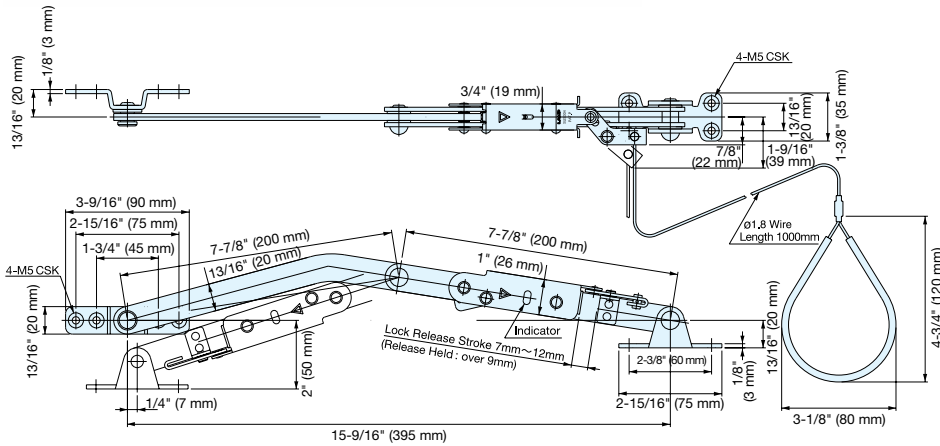
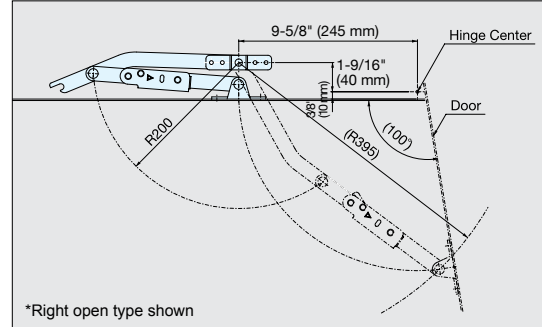

Installation of lock-release wire (WR and WL type only)

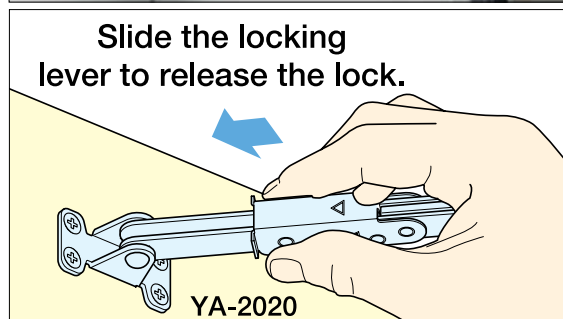
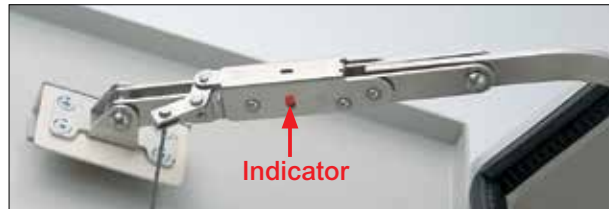
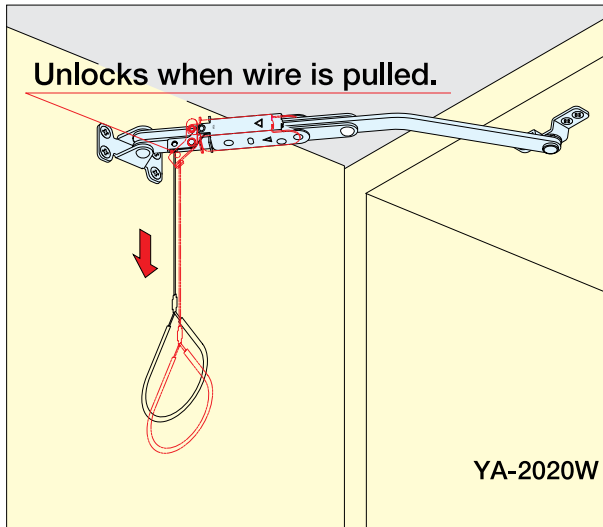

Material	Finish
304 Stainless Steel	Polished

Item No.	Type	Type	Weight (g)	Box (pcs)	Carton (pcs)
YA-2020WR	With Wire	Right Open	650	4	16
YA-2020WL		Left Open			
YA-2020R	Without Wire	Right Open	630		
YA-2020L		Left Open			