

SOFT-OPEN DAMPENING HINGE



HG-JHS9

HINGES

SOFT-OPEN DAMPENING HINGES

- Soft opening hinge, push latch sold separately.
- Built in damper for soft opening.
- Sold as a set.
- For inset applications.
- 105 degrees opening angle.



HG-JHS9-S

Black



HG-JHS9-U

White

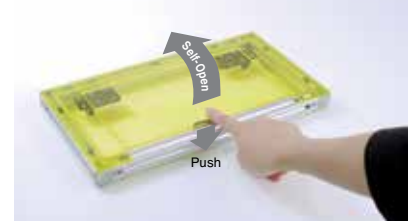

Push latch sold separately

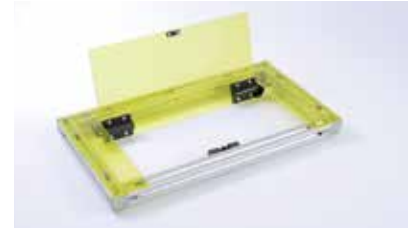

Side Mount

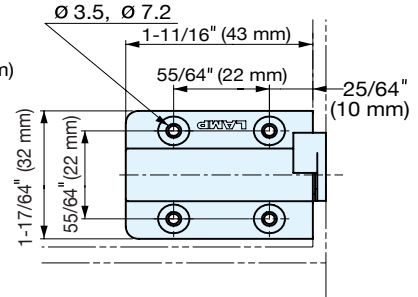
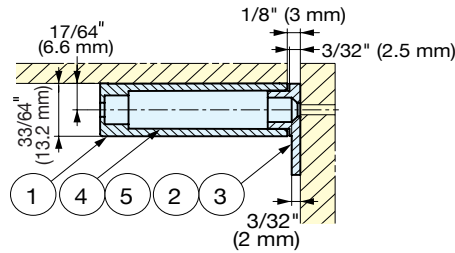
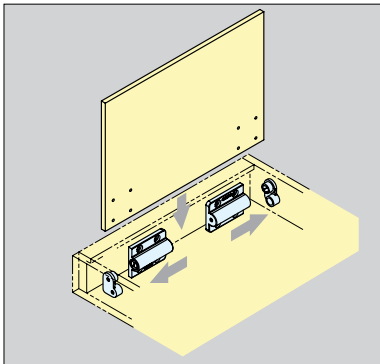

Under Mount

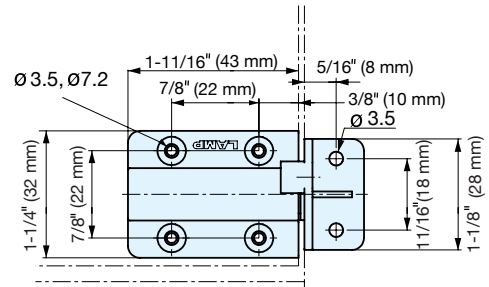
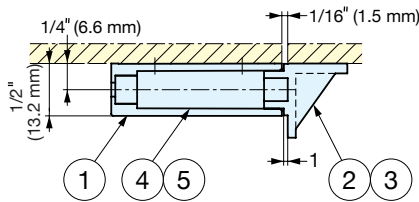
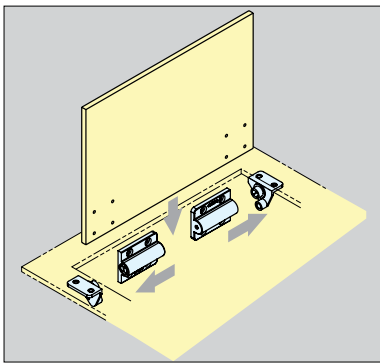

Item No.	Color	Type	Torque per piece
HG-JHS9-S-BL	Black	Side Panel Mount	0.24~0.38 lbs-in (0.28~0.44 kgf·cm)
HG-JHS9-S-WT	White		
HG-JHS9-U-BL	Black	Under Panel Mount	
HG-JHS9-U-WT	White		

No.	Part Name	Material	Finish
①	Bracket	Polyacetal	Black/White
②	Mounting Plate R	PBT plastic	
③	Mounting Plate L		
④	Damper	Polyacetal	-
⑤	Spring	Zinc Alloy	Spring