

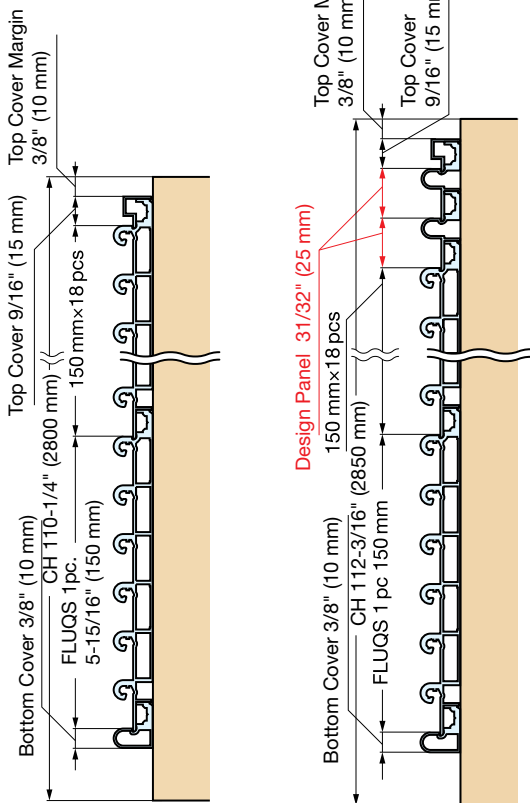

Installation Example
Ceiling Height (CH) :
110-1/4" (2800 mm)

Ceiling Height (CH) :
112-3/16" (2850 mm)



2 design panels are used to cover 1-31/32" (50 mm) space in case of ceiling height 112-3/16" (2850 mm).

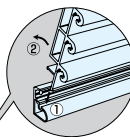
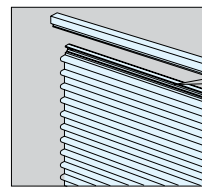
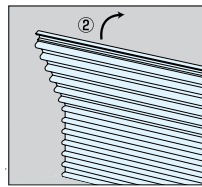
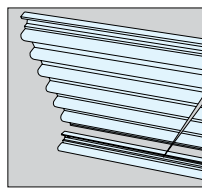
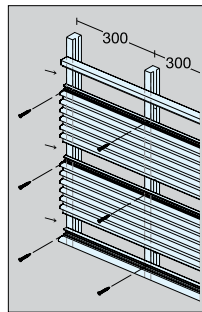

Install the bottom rail ①. Level the bottom rail before fastening. Insert the profile ② into the bottom rail. Fasten with screws.

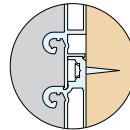

Install the profile ② until it reaches required height. The profile will cover the screws.

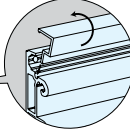

Snap-in the top rail to cover all the screws.

Corner Installation

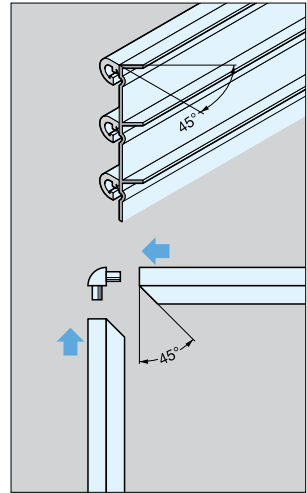

Corner Example

Part Details

No.	Item No.	Part Name	Dimensions	Material	Finish/Color	Length	Description
①	EX001-21	Main Panel FLUQS 250		Aluminum	Anodized	71-21/32" (1820 mm)	<ul style="list-style-type: none"> ● Basic Aluminum Wall Panel (Rail pitch 31/32" (25 mm)) ● Screw hole pitch 11-13/16" (300 mm)
②	EX004-21	Main Panel FLUQS 750		Aluminum	Anodized		<ul style="list-style-type: none"> ● Basic Aluminum Wall Panel (Rail pitch 2-15/16" (75 mm)) ● Screw hole pitch 11-13/16" (300 mm)
③	EX007-21	Top Cover		Aluminum	Anodized		<ul style="list-style-type: none"> ● Top Cover Track ● Covers the screw heads
④	EX008-21	Bottom Rail		Aluminum	Anodized		<ul style="list-style-type: none"> ● Bottom Track ● Screw hole pitch 11-13/16" (300 mm)
⑤	EX905-21	End Cap (1Way Type)		ABS	Matte Silver	-	-
⑥	EX906-21	End Cap (2Way Type)		ABS	Matte Silver	-	-
⑦	EX701-21	Design Panel 150	 Discontinued	Aluminum	Anodized	71-21/32" (1820 mm)	<ul style="list-style-type: none"> ● Panel with design pattern same as FLUQS 250 (25 mm rail pitch type) ● No Slot for Hooks/Shelves ● For space where the design pattern is needed but hooks/shelves are not necessary. ● Screw hole pitch 11-13/16" (300 mm)
⑧	EX709-21	Design Panel 25	 Discontinued	Aluminum	Anodized		<ul style="list-style-type: none"> ● Panel to adjust overall height (25 mm) ● No Slot for Hooks/Shelves ● Screw hole pitch 11-13/16" (300 mm)
⑨	EX009-21	Connector	 Discontinued	Aluminum	Anodized	31/32" (50 mm)	<ul style="list-style-type: none"> ● Used to align Panels ● Use 2 pcs per Panel (2 pcs per set)
⑩	EX901-21	Corner Angle	 EX901-21 FLUQS 22 20 15/16" (23 mm) 1/16" (1 mm) 118-1/8" (3000 mm) EX901-21 Board FLUQS 22 20 118-1/8" (3000 mm)	Aluminum	Anodized	118-1/8" (3000 mm)	<ul style="list-style-type: none"> ● Corner plate to cover the edge of aluminum panel. ● Screws not included

*Please see P.516~517 for accessories.