

# SHELF SUPPORT

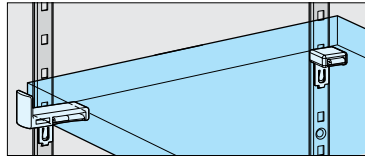

## AP-FA20

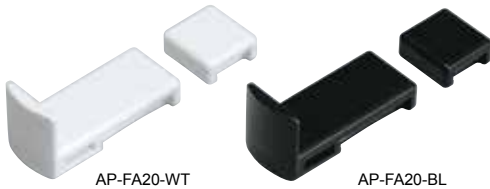

- Accessory plastic holder used with SPE, AP-DM, and AP-DH series shelf standards (all sold separately) to keep the shelf in position.
- Sold as a set with one front and back shelf holder.

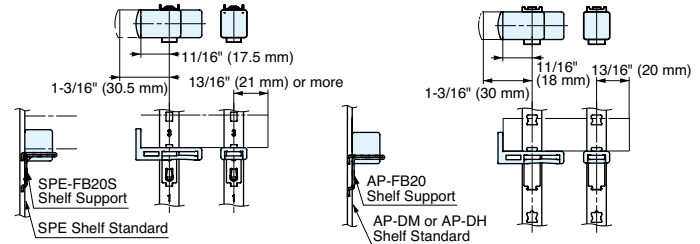
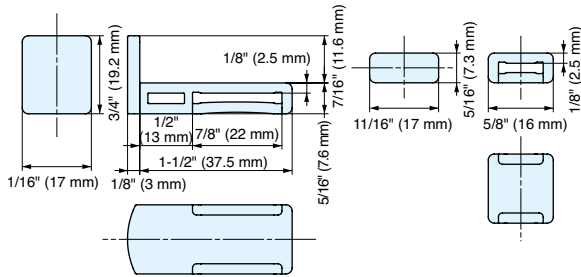

Item No.	Weight (g)	Material	Finish
AP-FA20/WT	4.9	Polyethylene	White
AP-FA20/BL			Black

Item No.	Shelf Thickness	Shelf standard center to front edge distance
AP-FB20	1/2" (12 mm)	18.0 - 30.0
SPE-FB20S		17.5 - 30.5
SPE-FB20SWT		17.5 - 30.5

# SHELF SUPPORTS



## AP-FK20



- Angle adjustable shelf clip.
- Can angle shelf up to 60°.
- Used in conjunction with the following parts: AP-FB20 shelf support, AP-DM/AP-DH series shelf standards.

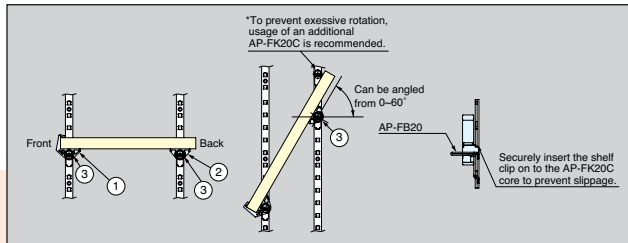
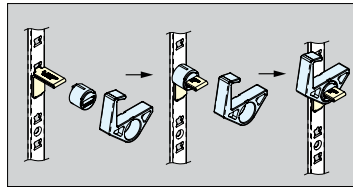
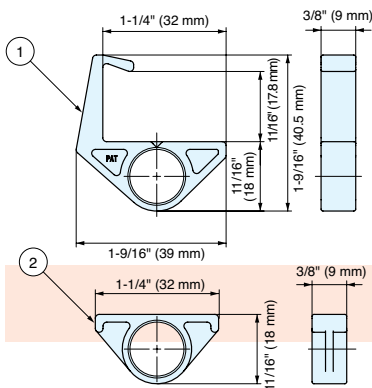

Item No.	Shelf Thickness	Load Capacity	Unit of Measurement
AP-FK20	11/16"-13/16" (18-20 mm)	98 N/10 kgf	Sold as set, front clip A and rear clip B

No.	Subcomponent	Material
①	Front Clip A	Polyacetal
②	Rear Clip B	
③	AP-FK20C Core (sold separately)	Polypropylene

# SHELF SUPPORT ACCESSORY CORE



## AP-FK20C

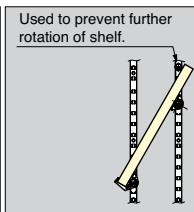
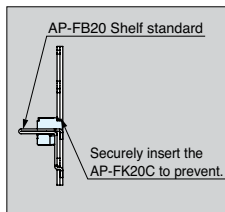
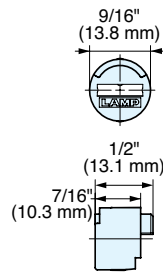

- Accessory used with AP-FB20 shelf supports, AP-FK20D angle adjustable clip, AP-FK20 angle adjustable clip set (sold separately).
- All items listed above is used with AP-DM and AP-DH shelf standards (also sold separately).

Item No.	Material	Finish
AP-FK20C	Polyethylene	White