



# MULTI-ROLLER LINEAR GUIDE

DRAWER SLIDES

MULTI-ROLLER LINEAR GUIDE

## ELEVATE YOUR PERFORMANCE

with the MLGX Multi-Roller Linear Guide. Its unique "Dual-X design" features 45° angled roller bearings that create consistent contact with the rail, ensuring smooth and stable motion even when operating under a moment load. It can also be mounted in various orientations while maintaining its level of performance.

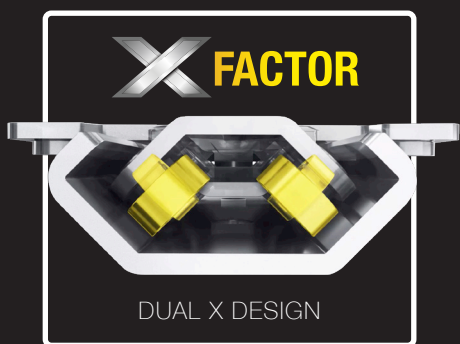

DUAL X DESIGN

**Dual X Structure:**  
Designed to facilitate reliable movement in any direction. Rollers are located at two different angles to resist both horizontal and vertical loads.

The MLGX Dual X Structure allows for:

SMOOTH & STABLE MOTION

VERSATILE MOUNTING DIRECTION

**27** lbs

UP TO 27 LBS OF OPERATING LOAD CAPACITY

PRELOADED CARRIAGE TO ELIMINATE RATTLE

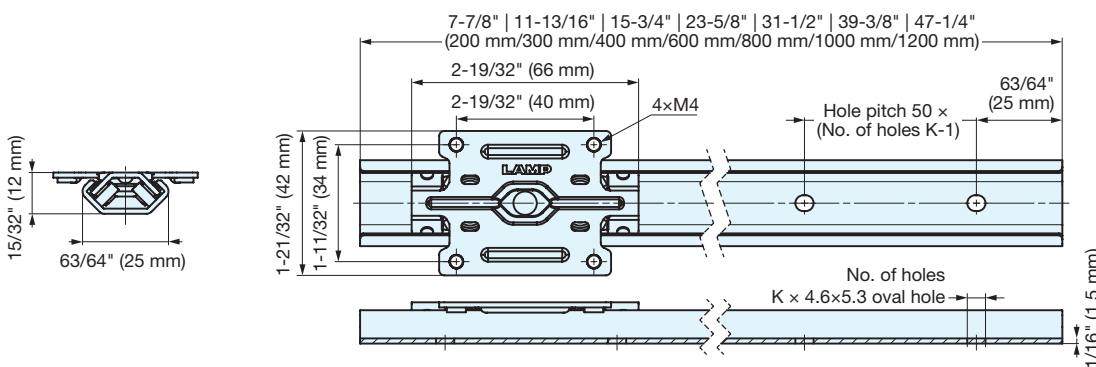

\* The figure shows the dimensions when the guide rail and a guide block are combined.

Rated Load Reference Values			
Loading Direction	Horizontal Load Fx	Vertical Load Fy	Horizontal Load Fv
Max. Load Capacity	44.9 lb (20.4 kg)	44.9 lbs (20.4 kg)	29.1 lbs (13.2 kg)
Operating Load	26.8 lbs (12.2 kg)	26.8 lbs (12.2 kg)	17.8 lbs (8.1 kg)
Loading Direction	Moment Mx	Moment My	Moment Mz
Max. Load Capacity	35.4 lbs-in (40.8 kg-cm)	17.7 lbs-in (20.4 kg-cm)	35.4 lbs-in (40.8 kg-cm)
Operating Load	21.2 lbs-in (24.4 kg-cm)	10.6 lbs-in (12.2 kg-cm)	21.2 lbs-in (24.4 kg-cm)

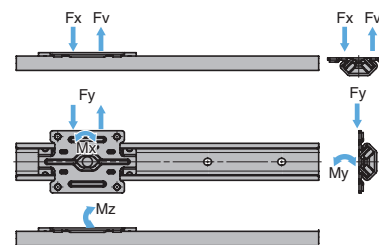

# MULTI-ROLLER LINEAR GUIDE RAIL



## MLGX25

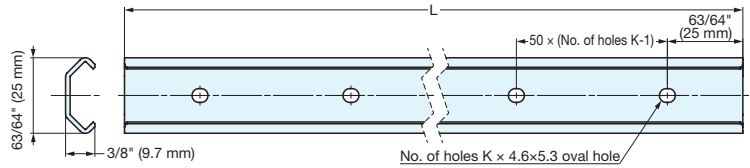

Item No.	L	No. of Holes (K)	Material	Weight (g)	Box (pcs)
MLGX25-200S	7-7/8" (200 mm)	4	304 Stainless Steel	86	1,850
MLGX25-300S	11-13/16" (300 mm)	6		130	2,270
MLGX25-400S	15-3/4" (400 mm)	8		173	2,680
MLGX25-600S	23-5/8" (600 mm)	12		258	3,350
MLGX25-800S	31-1/2" (800 mm)	16		344	4,450
MLGX25-1000S	39-3/8" (1000 mm)	20		430	5,560
MLGX25-1200S	47-1/4" (1200 mm)	24		516	6,700

# MULTI-ROLLER LINEAR GUIDE BLOCK



## MLGX-25C-8



Front

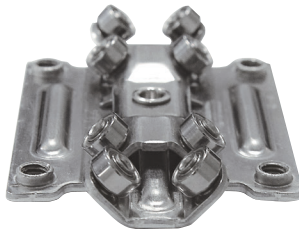

Back

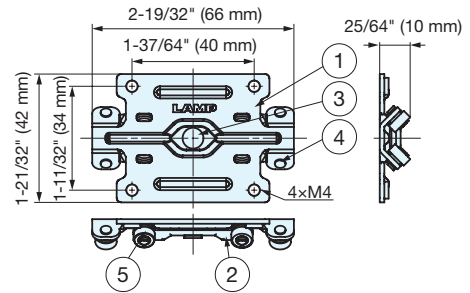

Multiple guide blocks can be used in a guide rail.

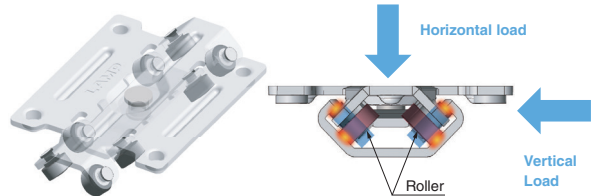

No.	Part Name	Material
①	Mounting Plate	304 Stainless Steel
②	Holding Plate	
③	Caulking Pin	303 Stainless Steel
④	Roller Pin	XM7 Stainless Steel
⑤	Roller Bearing	Steel

Item No.	Weight (g)	Box (pcs)
MLGX-25C-8	39	3,070

### Operating Load/Moment and Travel Distance (Life) Guidelines

Condition: 7.87 in./ sec of speed

