

TRUNK HANDLE



HCT-150



- 316 Stainless steel handle is ideal for harsh and highly corrosive environments.
- The handle is recessed into the mounting plate keeping it flush with the mounting surface.
- Spring loaded: Folds and returns to flat position to stay out of the way when not in use.
- 90 degree stop feature.
- Back mounted. Includes bracket for sheet metal applications.

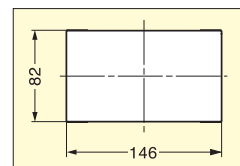
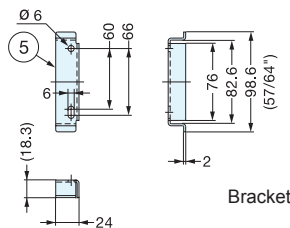
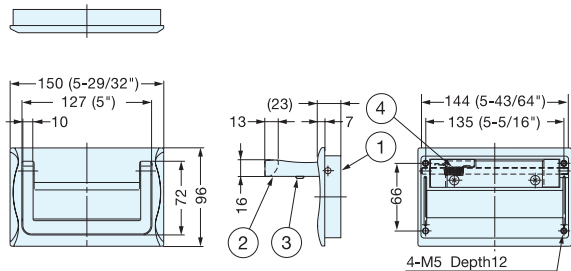

Cut Out Dimensions

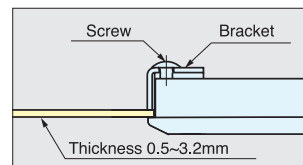

No.	Part Name	Material	Finish
①	Body	316 Stainless Steel	Mirror
②	Handle		
③	Bumper	Ethylene Propylene	Black
④	Spring	316 Stainless Steel	-
⑤	Bracket		Plain

Item No.	Material	Finish	Load Capacity (kg)	Load Capacity (lbs)	Weight (g)	Box (pcs)	Carton (pcs)
HCT-150	316 Stainless Steel	Mirror	100	220	990	5	20

TRUNK HANDLE



MUD-140



- The handle is recessed into the mounting plate keeping it flush with the mounting surface.
- Spring loaded:
Folds and returns to flat position to stay out of the way when not in use.
- 90 degree stop feature.
- Rubber pad on handle provides an easy and comfortable grip.
- Back mounted. Includes bracket for sheet metal applications.

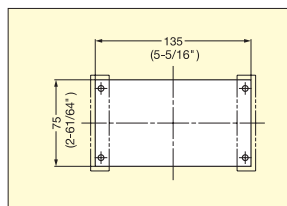
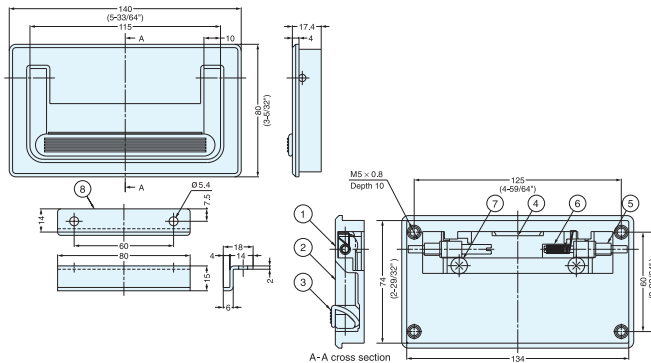

Cut Out Dimensions

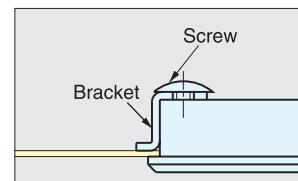

Installation

No.	Part Name	Material	Finish/Color
①	Body	Zinc Alloy	Chrome
②	Handle		
③	Grip	Synthetic Rubber	Black
④	Back Case	Steel	Yellow Zinc Chromate
⑤	Shaft	Zinc Alloy	
⑥	Spring	Steel	
⑦	Screw		
⑧	Bracket		

Item No.	Load Capacity (kg)	Weight (g)	Box (pcs)	Carton (pcs)
MUD-140	30 (66 lbs)	620	5	20