

MULTI-PURPOSE LID W/DAMPER



AZ-GD231-HL



- Installed from the inside of the waste box for clean appearance.
- With damper to keep the lid from slamming shut.
- Integrated with anti-pinching plates.
- Corrosion resistant.
- Guide sold separately (AZ-SLP)



[Application Example]

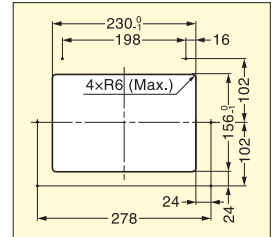
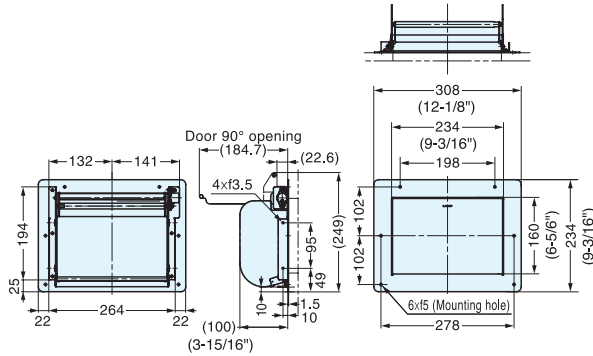

Cut Out Dimensions

Item No.	L	H	D	Weight (g)	Box (pcs)	Carton (pcs)	Material	Finish
AZ-GD231-HL	308 (12-1/8")	234 (9-3/16")	100 (3-15/16")	1486	1	10	304 Stainless Steel	Satin

MULTI-PURPOSE LID W/DAMPER



AZ-GD232-HL



- Able to install the lid up to 45°.
- Inclined mount.
- Easy to adjust angle by changing the weight position.
- Integrated anti-pinching plates.
- Corrosion resistant.
- Guide sold separately.

[Installation]

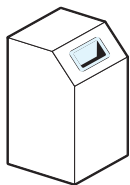

[How to Adjust Angle]

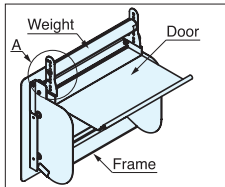

Max. 45°

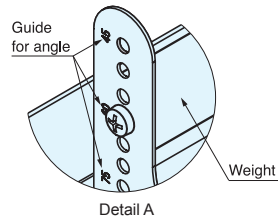

Detail A

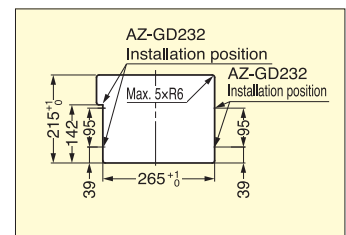
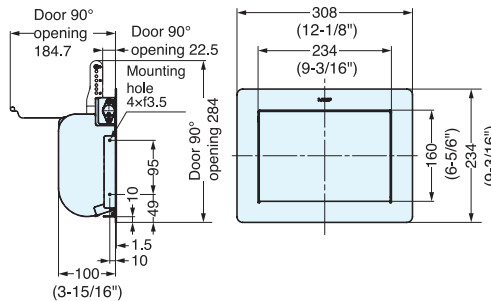

Cut Out Dimensions

Item No.	L	H	D	Weight (g)	Box (pcs)	Carton (pcs)	Material	Finish
AZ-GD232-HL	308 (12-1/8")	234 (9-3/16")	100 (3-15/16")	2200	1	10	304 Stainless Steel	Satin