

RECESSED PULL

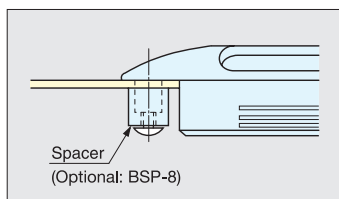

UTZ-130

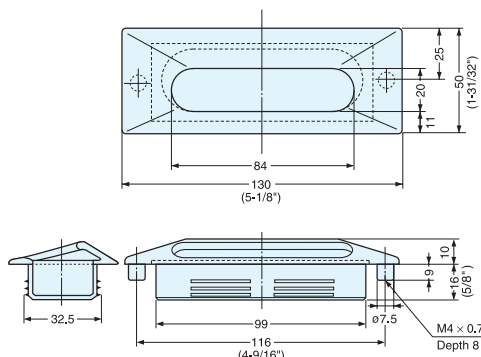

Sheet metal mounting application

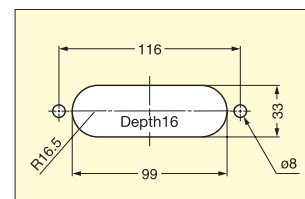

Bore Dimensions

Item No.	Weight (g)	Box (pcs)	Carton (pcs)
UTZ-130/CR	105	10	60
UTZ-130/SN			
UTZ-130/SB			

Material	Finish/Color
Zinc Alloy	Chrome (CR)/Satin Nickel (SN)/Satin Bronze (SB)
Plastic	Black

RECESSED PULL



SD-160

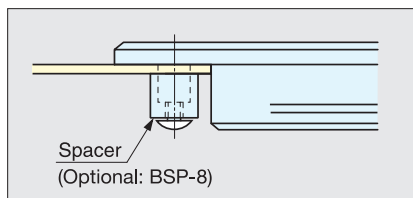
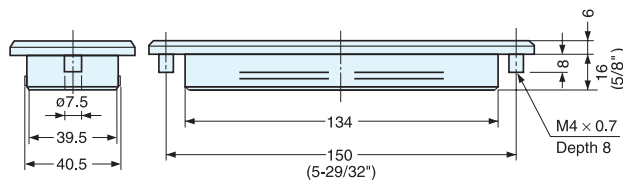
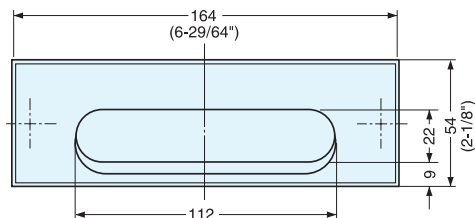

Sheet metal mounting application

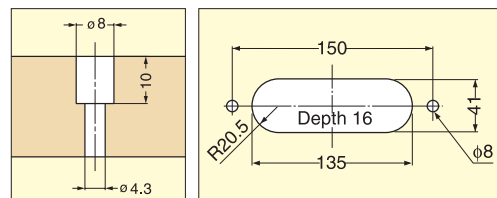

Bore Dimensions

Item No.	Weight (g)	Box (pcs)	Carton (pcs)
SD-160/CR	165	10	60
SD-160/SN			

Material	Finish/Color
Zinc Alloy	Chrome (CR)/Satin Nickel (SN)
Plastic	Black