

TORQUE HINGE

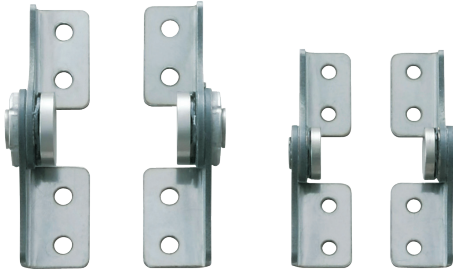

HG-TA



- Free stop hinge with friction torque.
- Consistent torque through out working range.
- Opening angle 0°~180°.

- Applications:
- Ideal for indoor applications.
 - LCD monitors, stationary cameras, displays, etc.

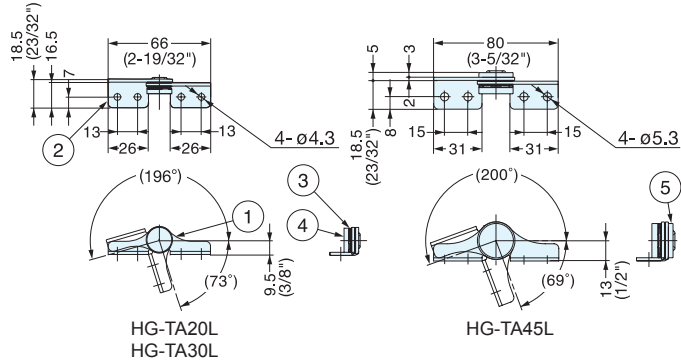

Item No.	Type	Torque per piece (kgf-cm)	Weight (g)	Box (pcs)	Carton (pcs)
HG-TA20R	Right hand	20.4 ±20% (17.7 lbs-in ±20%)	30	40	320
HG-TA20L	Left hand				
HG-TA30R	Right hand	30.6 ±20% (26.5 lbs-in ±20%)	30	40	320
HG-TA30L	Left hand				
HG-TA45R	Right hand	45.9 ±20% (39.8 lbs-in ±20%)	65	20	160
HG-TA45L	Left hand				

No	Part Name	Material	Finish
①	Hinge A	430 Stainless Steel	Plain
②	Hinge B		
③	Spring Washer	Steel	-
④	Shaft	303 Stainless Steel	-
⑤	Washer	430 Stainless Steel	-

TORQUE HINGE



HG-TB

HG-TB7L
HG-TB20L
HG-TB30L

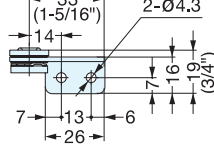

HG-TB45L

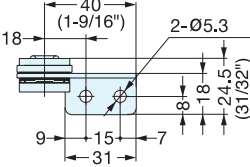

2-Ø4.6, Ø 8.8

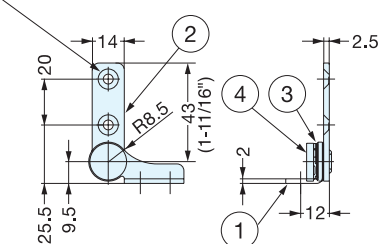

Left-handed type shown

2-Ø5.6, Ø10.8

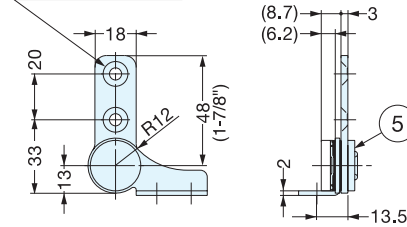

- Free stop hinge with friction torque.
- Consistent torque through out working range.
- Opening angle 360°.

- Applications:
- Ideal for indoor applications.
 - LCD monitors, stationary cameras, displays, etc.

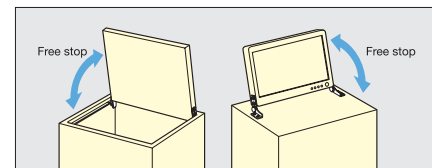

Item No.	Type	Torque per piece (kgf-cm)	Weight (g)	Box (pcs)	Carton (pcs)
HG-TB7R	Right hand	7.1±20% (6.1 lbs-in ±20%)	30	40	320
HG-TB7L	Left hand				
HG-TB20R	Right hand	20.4±20% (17.7 lbs-in ±20%)	30	40	320
HG-TB20L	Left hand				
HG-TB30R	Right hand	30.6±20% (26.5 lbs-in ±20%)	30	40	320
HG-TB30L	Left hand				
HG-TB45R	Right hand	45.9±20% (39.8 lbs-in ±20%)	65	20	160
HG-TB45L	Left hand				

No	Part Name	Material	Finish
①	Hinge A	430 Stainless Steel	Plain
②	Hinge B		
③	Spring Washer	Steel	-
④	Shaft	303 Stainless Steel	-
⑤	Washer	430 Stainless Steel	-