

# KNUCKLE CATCH

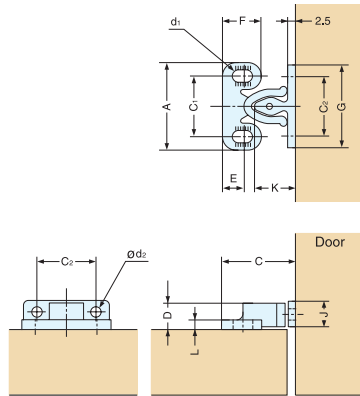

# D-CATCH

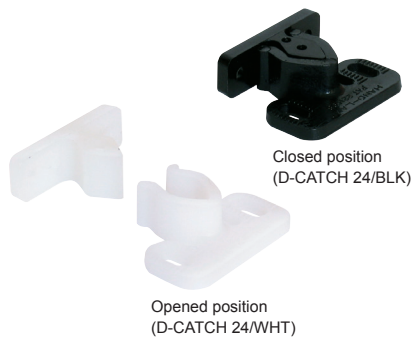

- Grabs and holds doors tightly.

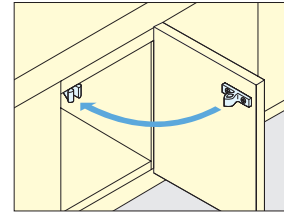

Installation

\* Please specify color when ordering.

Part Name	Material	Color
Catch	Polyacetal	Natural White(WHT) Black (BLK)
Strike	Polyamide	

Item No.	Push in Force (kg)	Pulling Force (kg)	A	C <sub>1</sub>	C	D	E	F	G	C <sub>2</sub>	J	K	L	d <sub>1</sub>	d <sub>2</sub>	Weight (g)	Box (pcs)	Carton (pcs)
D-CATCH 24/WHT	3.1 (6.8 lbs)	2.7 (5.9 lbs)	24 (15/16")	17	21.5	7.5	7	12	22 (7/8")	15.5	7.5	12.5	2	2.5×5.5	2.5	1.5	100	2000
D-CATCH 24/BLK																		

# KNUCKLE CATCH



# K-CATCH

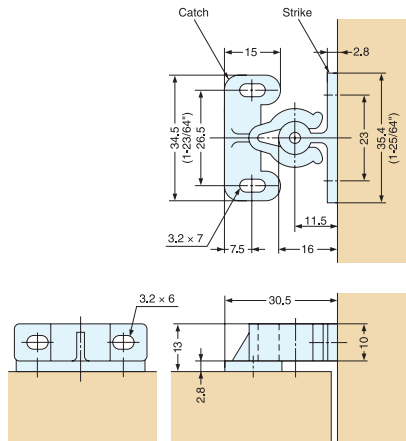

- Grabs and holds doors tightly.

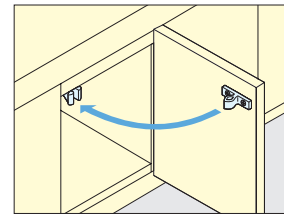

Installation

Part Name	Material	Color
Catch	Polyacetal	White
Strike	Polyamide	

Item No.	Push in Force (kg)	Pulling Force (kg)	Weight (g)	Box (pcs)	Carton (pcs)
K-CATCH/WHT-T	5.7 (12.5 lbs)	7.1 (15.6 lbs)	4.5	100	1000

# SNAP-IN KNUCKLE CATCH



# JCU-F

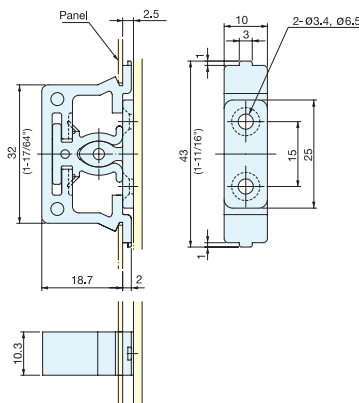
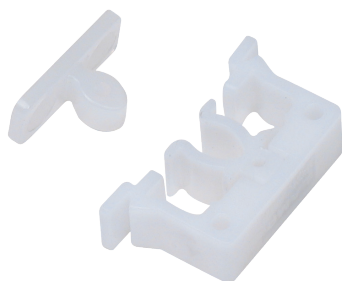

- Grabs and holds doors tightly.
- Snap-in type body for easy installation.
- Designed for sheet metal or plastic panel applications.
- Internal catch body slides 1.5 mm for better alignment.

Part Name	Material	Color
Catch	Polyacetal	White
Strike	Polyamide	

Panel Thickness	Cut Out Dimensions
0.8 mm	32.3 × 10.1
1.0 mm	32.9 × 10.1
1.2 mm	33.8 × 10.1

Item No.	Push in Force (kg)	Pulling Force (kg)	Weight (g)	Box (pcs)	Carton (pcs)
JCU-F	2 (4.4 lbs)	2 (4.4 lbs)	5.2	40	800